



PAPILLON

Material: Alu. die cast trim with powder coating finish, Alu. forging heatsink, Plastic baffle can be plated or coated with black, white, piano black or chrome finishes





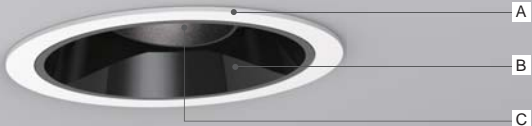

With cutoff 35 degrees design, providing glareless UGR<19; decrease the appearance of light in the area. Light engine can be assemble / disassemble without tool. 15/24/38 degrees beam angle to choose from, accessories are also available for different lighting application.

Residential, shop, office, restaurant & bar, museum, art gallery, showroom.

PAPILLON



Color available - A / C

- | | | | |
|---|---|---|---|
|  |  | | |
| White | Black | | |
| B | | | |
|  |  |  |  |
| White | Black | Piano black | Chrome |

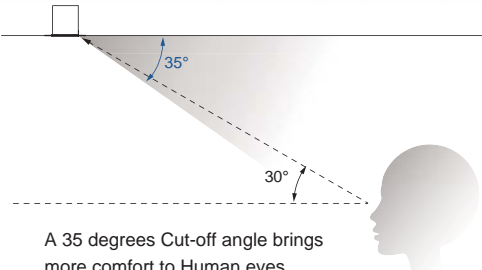
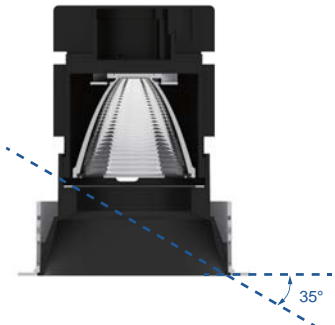

A 35 degrees Cut-off angle brings more comfort to Human eyes.

PAPILLON



Adding snoot to reduce field angle as much as possible, and more focused on the object.





Article number	1718.225
LED Consumption	12.8W
Current	350 (mA)
Lumen	1387 (lm)
Beam Angle	15°/24°/38°
CCT	3000K
CRI	90+

Color available :



Dimmable

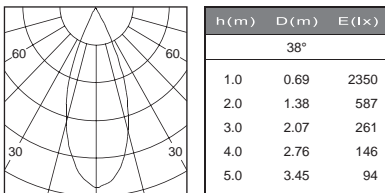
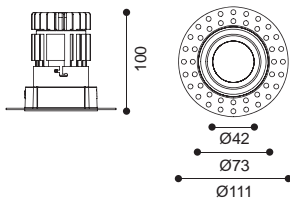

Accessories



SG7-1 striped glass H7-1 honeycomb louver DS7-1 diffusion sheet S7-1 snoot



Article number	1718.226
LED Consumption	12.8W
Current	350 (mA)
Lumen	1387 (lm)
Beam Angle	15°/24°/38°
CCT	3000K
CRI	90+

Color available :

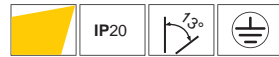

Dimmable

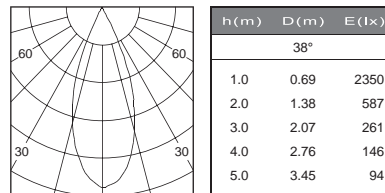
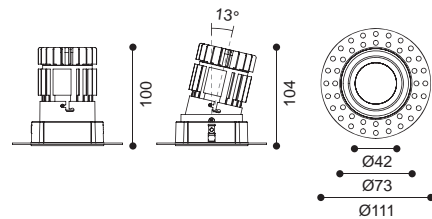

Accessories



SG7-1 striped glass H7-1 honeycomb louver DS7-1 diffusion sheet S7-1 snoot



Article number	1718.166
LED Consumption	12.8W
Current	350 (mA)
Lumen	1387 (lm)
Beam Angle	15°/24°/38°
CCT	3000K
CRI	90+

Color available :



Dimmable

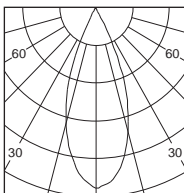
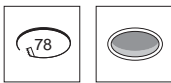
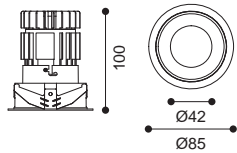

h (m)	D (m)	E (lx)
38°		
1.0	0.69	2350
2.0	1.38	587
3.0	2.07	261
4.0	2.76	146
5.0	3.45	94

Accessories



SG7-1 striped glass H7-1 honeycomb louver DS7-1 diffusion sheet S7-1 snoot



Article number	1718.167
LED Consumption	12.8W
Current	350 (mA)
Lumen	1387 (lm)
Beam Angle	15°/24°/38°
CCT	3000K
CRI	90+

Color available :

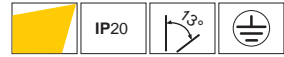

Dimmable

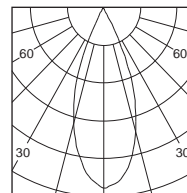
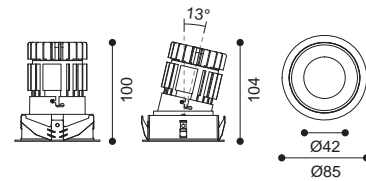

h (m)	D (m)	E (lx)
38°		
1.0	0.69	2350
2.0	1.38	587
3.0	2.07	261
4.0	2.76	146
5.0	3.45	94

Accessories



SG7-1 striped glass H7-1 honeycomb louver DS7-1 diffusion sheet S7-1 snoot



Article number	1718.145
LED Consumption	12.8W
Current	350 (mA)
Lumen	1387 (lm)
Beam Angle	15°/24°/38°
CCT	3000K
CRI	90+

Color available :



Dimmable

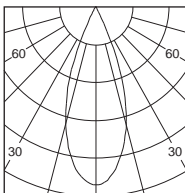
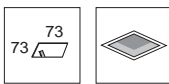
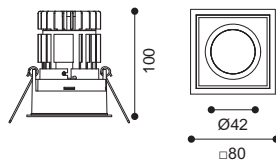

h (m)	D (m)	E (lx)
38°		
1.0	0.67	2327
2.0	1.34	581
3.0	2.01	258
4.0	2.69	145
5.0	3.36	93

Accessories



SG7-1 striped glass H7-1 honeycomb louver DS7-1 diffusion sheet S7-1 snoot



Article number	1718.146
LED Consumption	12.8W
Current	350 (mA)
Lumen	1387 (lm)
Beam Angle	15°/24°/38°
CCT	3000K
CRI	90+

Color available :

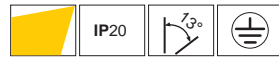

Dimmable

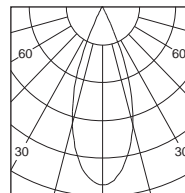
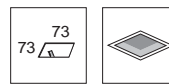
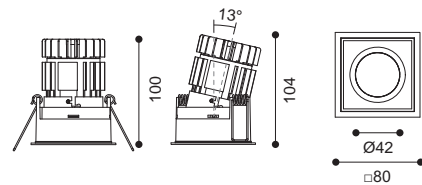

h (m)	D (m)	E (lx)
38°		
1.0	0.67	2327
2.0	1.34	581
3.0	2.01	258
4.0	2.69	145
5.0	3.36	93

Accessories



SG7-1 striped glass H7-1 honeycomb louver DS7-1 diffusion sheet S7-1 snoot