

INSTALLATION INSTRUCTION

1. The fixture is for LED.
2. Before installation, make sure that the power supply is off.
3. Follow the steps as down below for installation or replacement of bulb.
4. After finishing every step, tighten the screws, have the fixture fixed, then connect the power supply.
5. It is recommended that these products are installed by a qualified electrician.

A

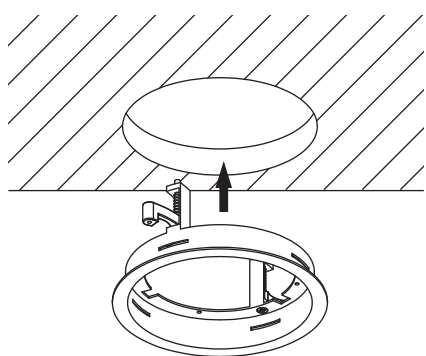

B

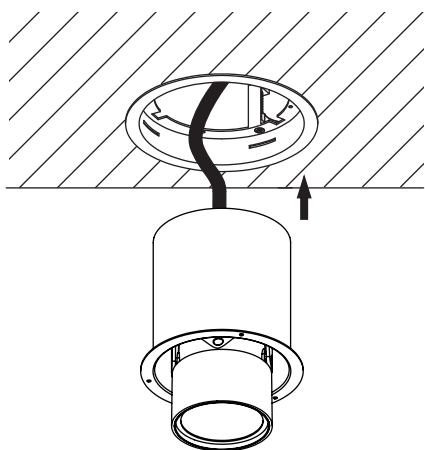

C

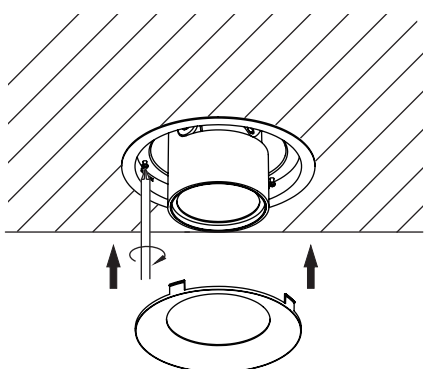

①

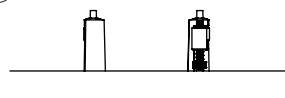

②

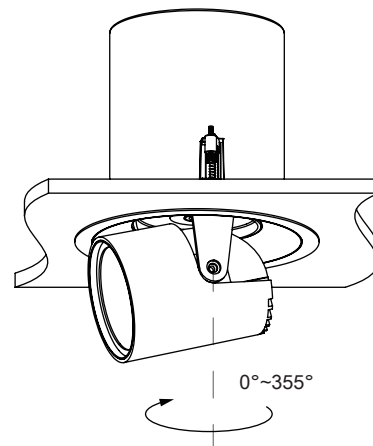
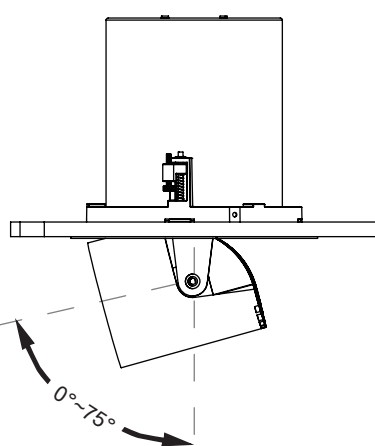
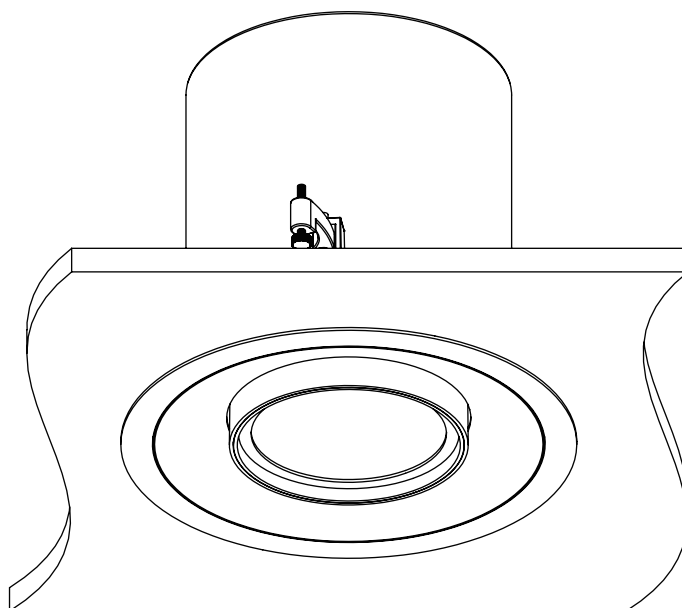
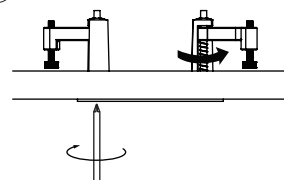

Ø 148mm

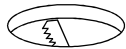

IP20 CE

