



CHAIN (AM) system



CHAIN (AM)

CHAIN, an extension of our TRUNKING system
Modulized design for easy assembling L corner
is designed to make turns.

Spot & pendant modules are also available for
different applications.

CHAIN PROFILE

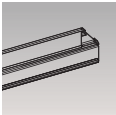

TEC

Aluminum profile

P.139

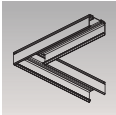

TEC-14

Aluminum profile 90°

P.139

CHAIN MODULES

	Series name	LED Consumption	Lumen	
 	CHAIN-L	28W	2800 (lm)	P.140
 	CHAIN-P	28W 56W	2500 (lm) 5000 (lm)	P.141
 	CHAIN-L-H	72W	7000 (lm)	P.142
 	CHAIN-P-H	72W	6840 (lm)	P.143
 	CHAIN-S	12.8W 25.5W	1387 (lm) 2670 (lm)	P.144
 	CHAIN-C	6.4W 12.8W	542 (lm) 1387 (lm)	P.145

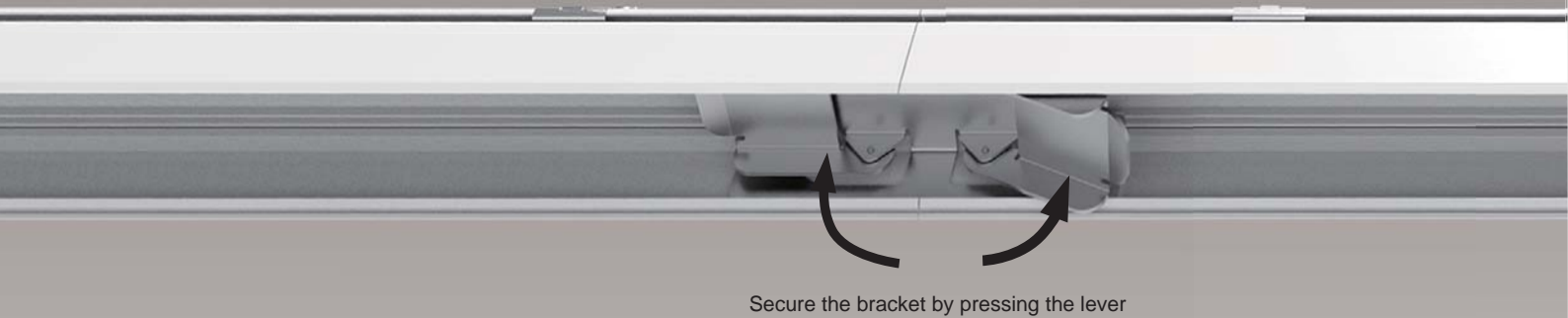
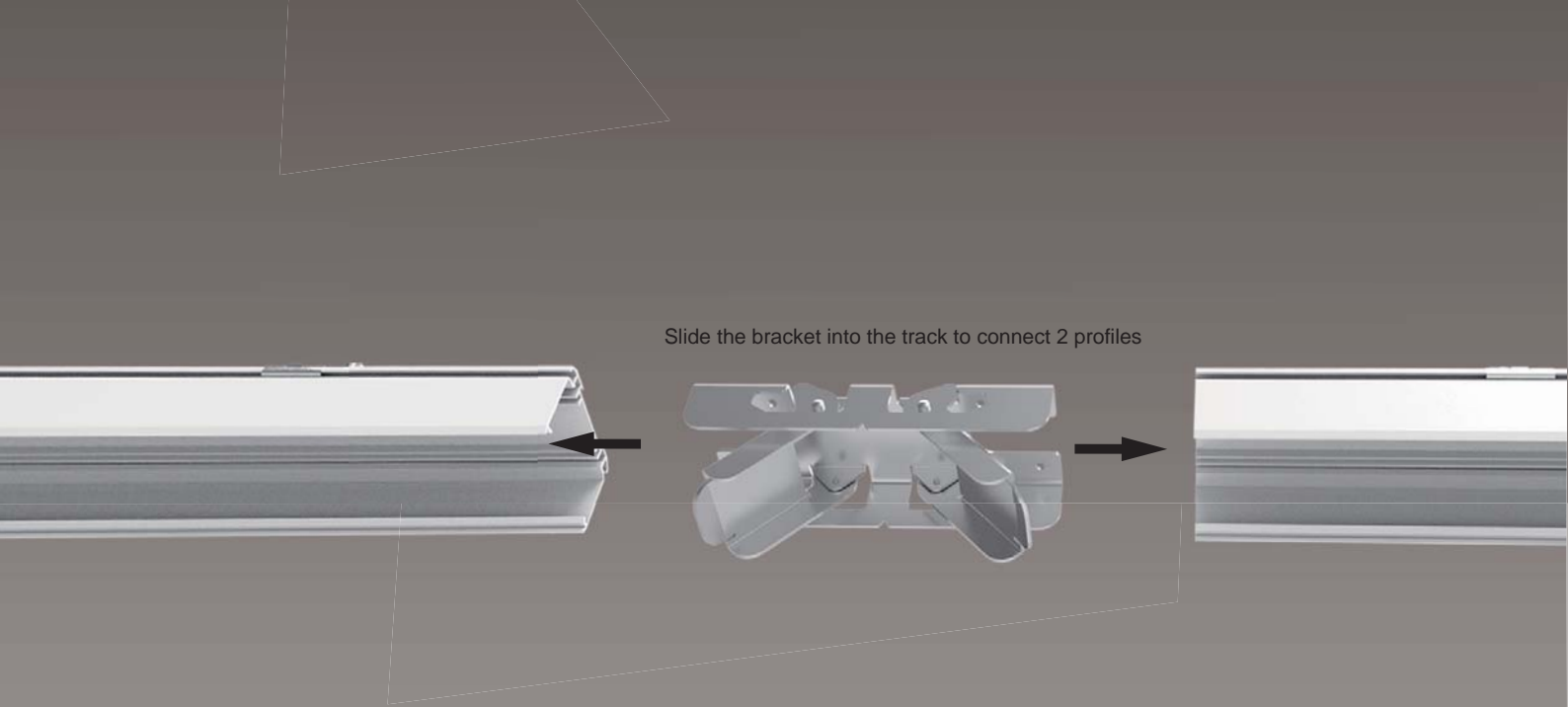

Max. current for the connector is 7A, Max. 1540W @ 230V AC

1717.102A / 1717.103A(28W)

Max. linkable 58pcs @ 230V AC

1717.102B / 1717.103B(56W)

Max. linkable 28pcs @ 230V AC

1717.105A / 1717.106A(72W)

Max. linkable 21pcs @ 230V AC

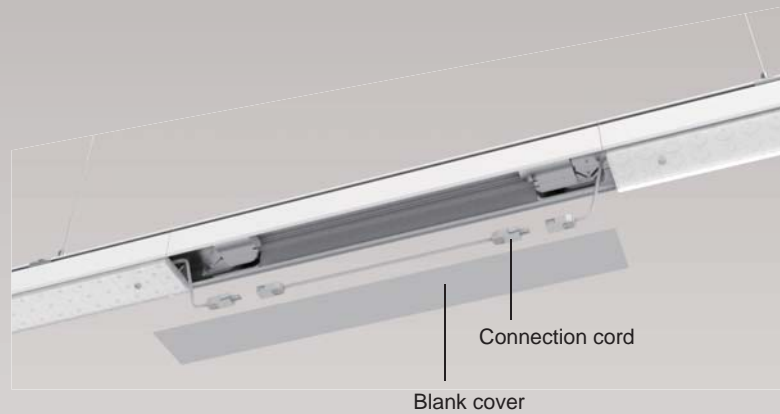
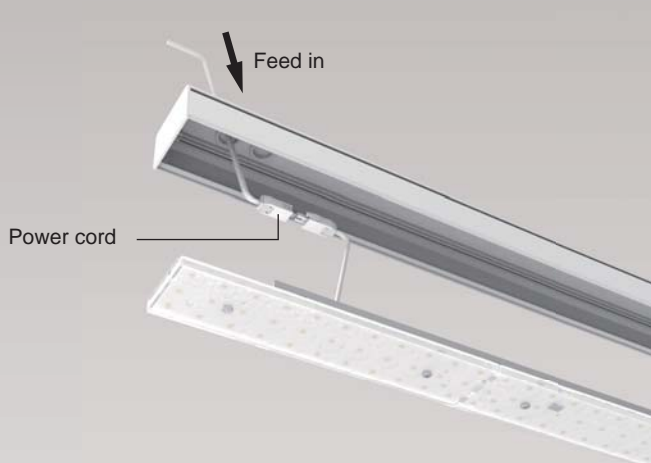

Surface mounted & pendant

Fast connection for profile

Fast connection for power

smooth & even lighting effect

SMD LED provides 110lm/W effective output.

Different beam angle lens are available

Unlock

Lock

CHAIN (AM)

Surface mounted

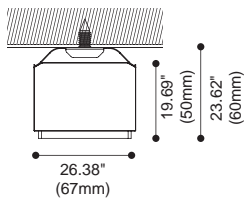

CHAIN-L

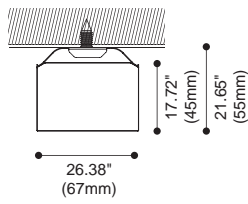

CHAIN-P

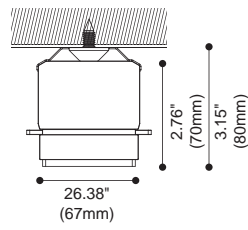

CHAIN-L-H

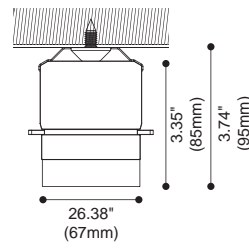

CHAIN-P-H

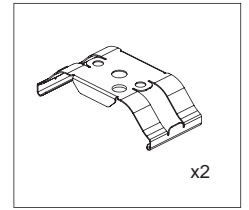

Article number : TRF-01
Surface Mounted clip.



Pendant kit

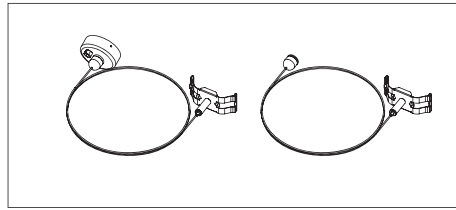

Article number : TEI-03
Length:1500mm

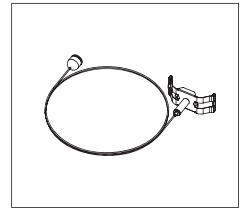

Article number : TEI-04
Length:1500mm



CHAIN (AM)

modules & accessories

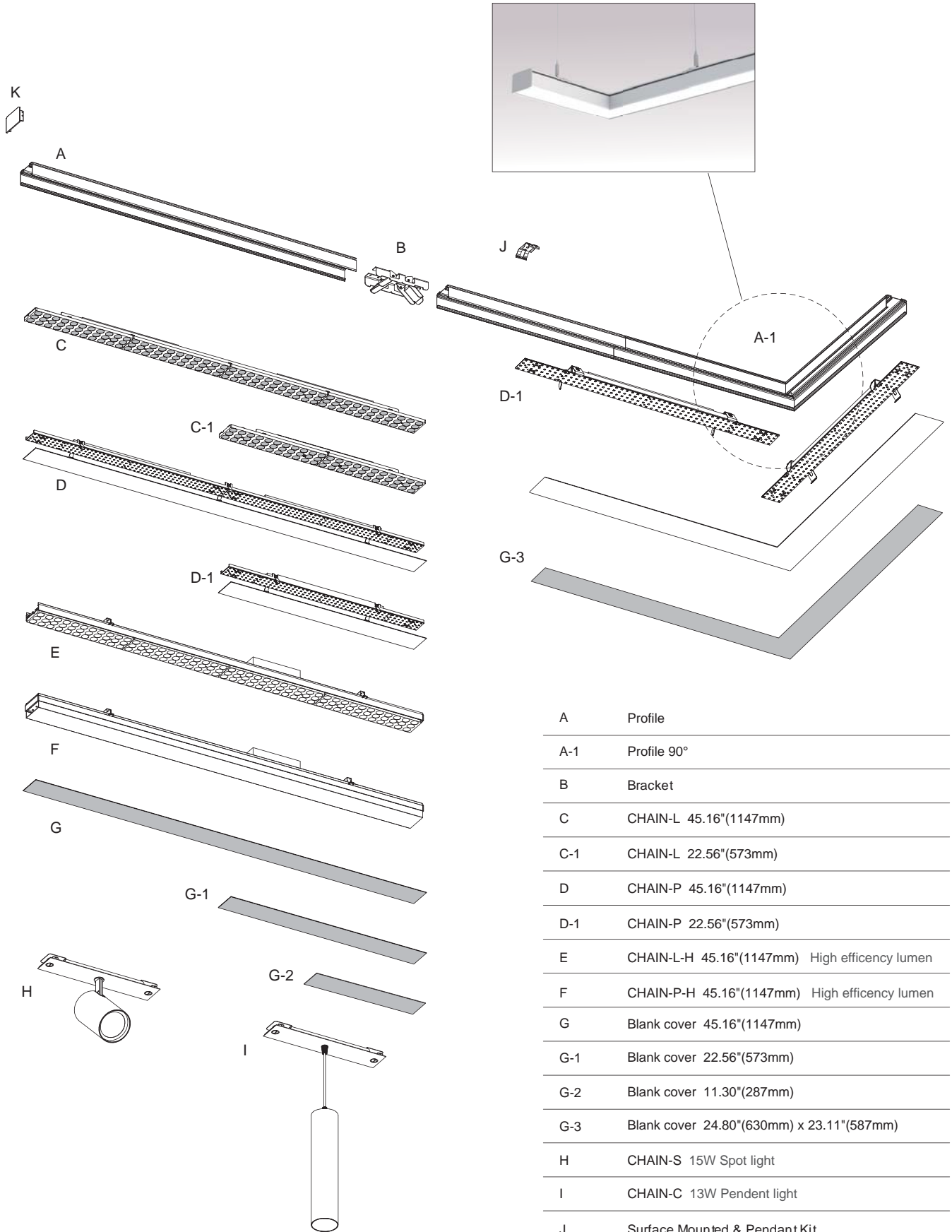

A	Profile
A-1	Profile 90°
B	Bracket
C	CHAIN-L 45.16"(1147mm)
C-1	CHAIN-L 22.56"(573mm)
D	CHAIN-P 45.16"(1147mm)
D-1	CHAIN-P 22.56"(573mm)
E	CHAIN-L-H 45.16"(1147mm) High efficiency lumen
F	CHAIN-P-H 45.16"(1147mm) High efficiency lumen
G	Blank cover 45.16"(1147mm)
G-1	Blank cover 22.56"(573mm)
G-2	Blank cover 11.30"(287mm)
G-3	Blank cover 24.80"(630mm) x 23.11"(587mm)
H	CHAIN-S 15W Spot light
I	CHAIN-C 13W Pendant light
J	Surface Mounted & Pendant Kit
K	End Cap

Components

Profile

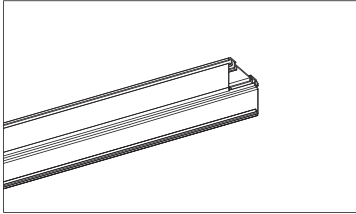

Article number	L
TEC-02	45.20"(1148mm)
TEC-06	90.39"(2296mm)

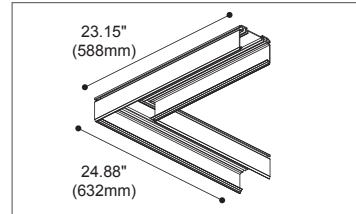

Article number	L
TEC-14	24.88"(632mm) x 23.15"(588mm)

Bracket

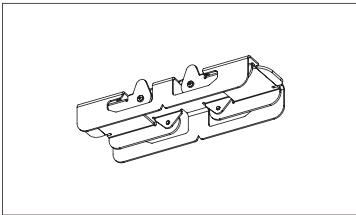

Article number	L
TEC-15	

End cap

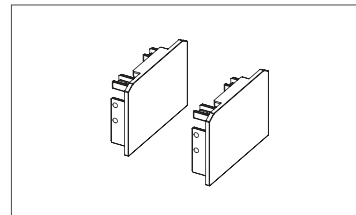

Article number	L
TEC-08	

Blank cover

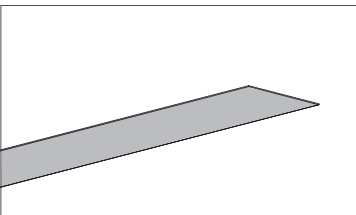

Article number	L
TEE-03	45.16"(1147mm)
TEE-04	22.56"(573mm)
TEE-05	11.30"(287mm)

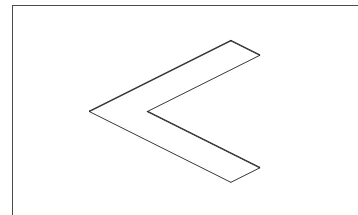

Article number	L
TEE-06	24.80"(630mm) x 23.11"(587mm) Milky Diffuser
TEE-07	24.80"(630mm) x 23.11"(587mm) Blank cover

Power cord

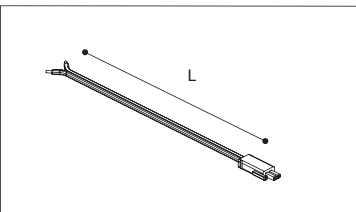

Article number	L
TEC-07	74.80"(1900mm)

Connection cord

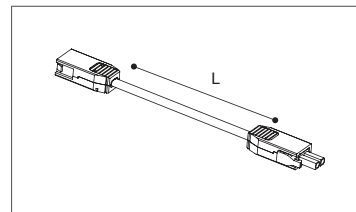

Article number	L
TEC-10	11.81"(300mm)
TEC-11	23.62"(600mm)
TEC-13	47.24"(1200mm)

CHAIN-L

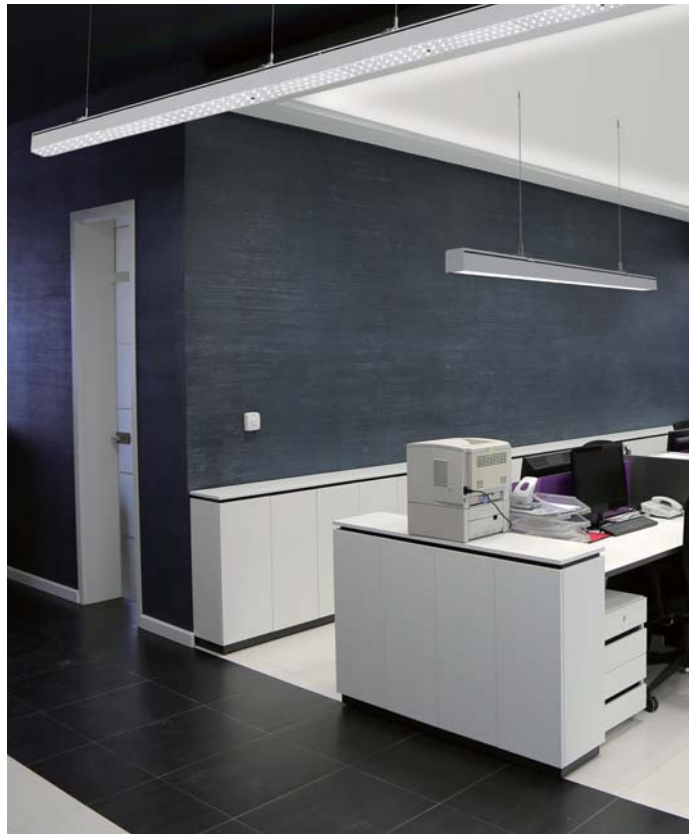
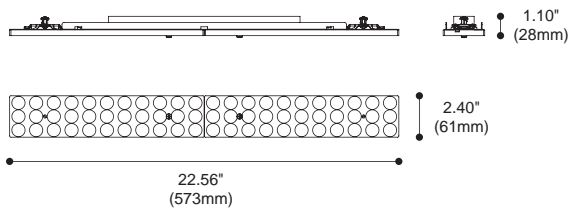

Colours White

Product performance

Article number	LED Consumption	Voltage	System Lumen	Beam Angle	LED Type	LED q'ty	CCT/CRI
1717.102A-AM	28 W	230V AC	2800 (lm)	30°/60°/90°/Double 20°	SMD	66	40/80+



CHAIN-P

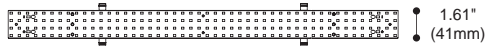
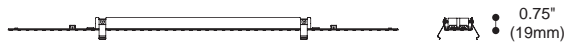

1717.103A : 22.56"(573mm)
1717.103B : 45.16"(1147mm)

Milky Diffuser

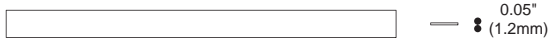

1717.103A : 22.56"(573mm)
1717.103B : 45.16"(1147mm)



1717.103A-AM

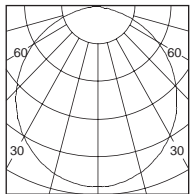

h (m)	D (m)	E (lx)
		112°
1.0	0.52	9909
2.0	1.05	2477
3.0	1.58	1101
4.0	2.11	619
5.0	2.64	396

1717.103B-AM

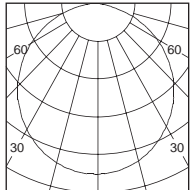

h (m)	D (m)	E (lx)
		107°
1.0	0.52	9909
2.0	1.05	2477
3.0	1.58	1101
4.0	2.11	619
5.0	2.64	396

Colours White

Product performance

Article number	LED Consumption	Voltage	System Lumen	Beam Angle	LED Type	LED q'ty	CCT/CRI
1717.103A-AM	28 W	230V AC	2500 (lm)	120°	SMD	192	40/80+
1717.103B-AM	56 W	230V AC	5000 (lm)	120°	SMD	384	40/80+



CHAIN-L-H

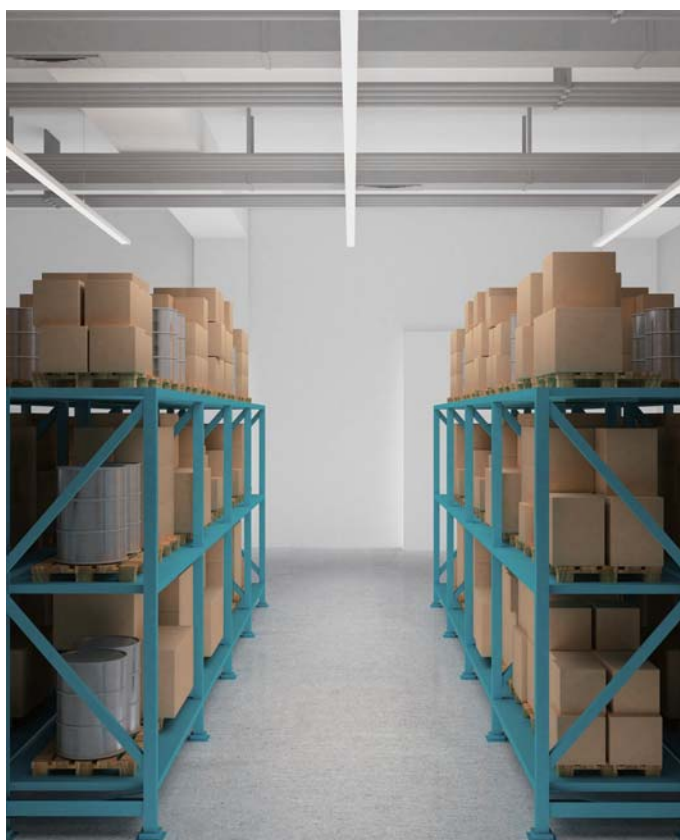
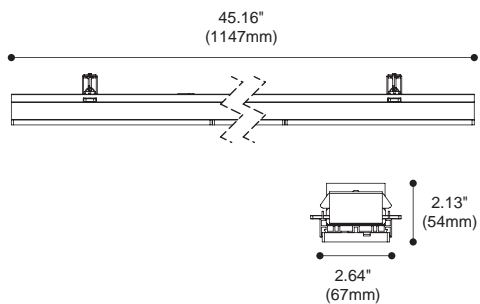

Colours White

Product performance

Article number	LED Consumption	Voltage	System Lumen	Beam Angle	LED Type	LED q'ty	CCT/CRI
1717.105A-AM	72 W	230V AC	7000 (lm)	30°/60°/90°/Double 20°	SMD	132	40/80+



CHAIN-P-H

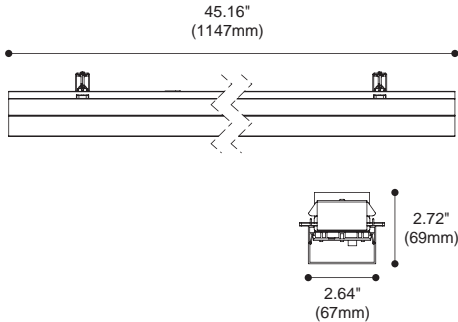

Colours White

Product performance

Article number	LED Consumption	Voltage	System Lumen	Beam Angle	LED Type	LED q'ty	CCT/CRI
1717.106A-AM	72 W	230V AC	6840 (lm)	120°	SMD	432	40/80+



CHAIN-S

12.8 W

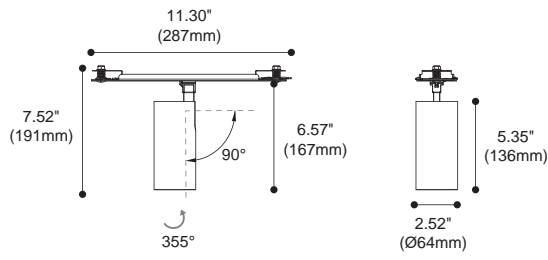

25.5 W

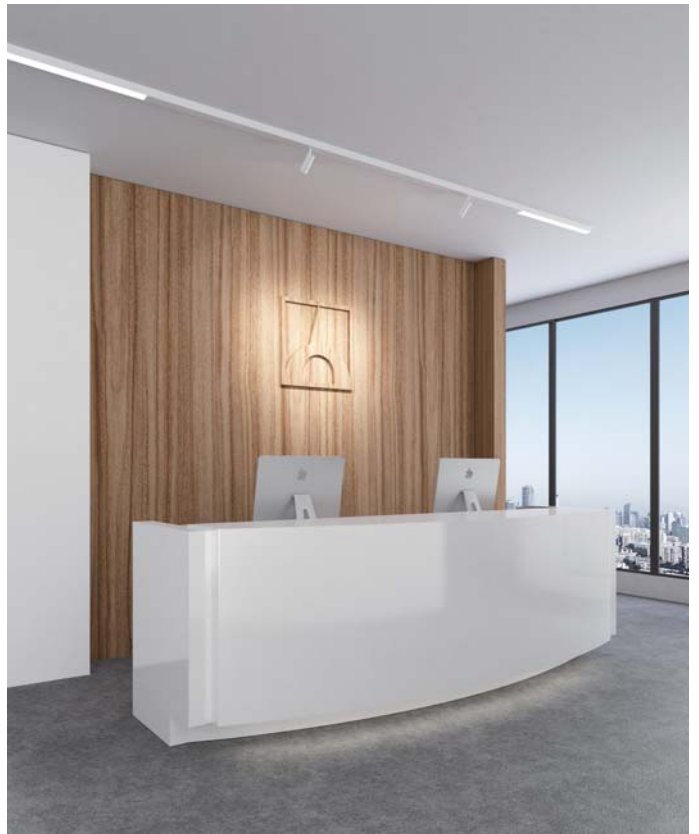
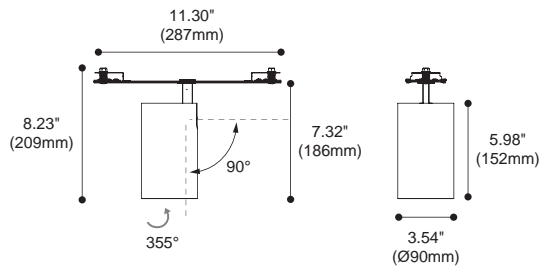

- Colours ● ○
 Black White
 Baffle : ● ○
 Black White

Product performance

Article number	LED Consumption	Voltage	Lumen	Beam Angle	CCT/CRI
1717.108-AM	12.8W	230V AC	1387 (lm)	10°/20°/30°	30/90+
1717.109-AM	25.5W	230V AC	2670 (lm)	10°/20°/30°	30/90+



CHAIN-C

6.4 W

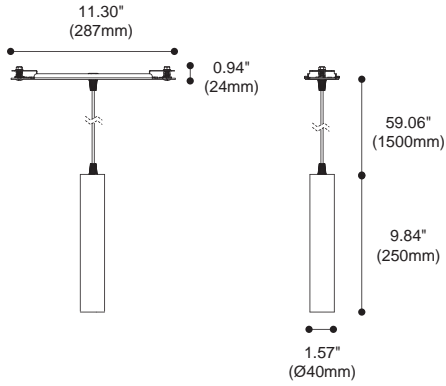

12.8 W

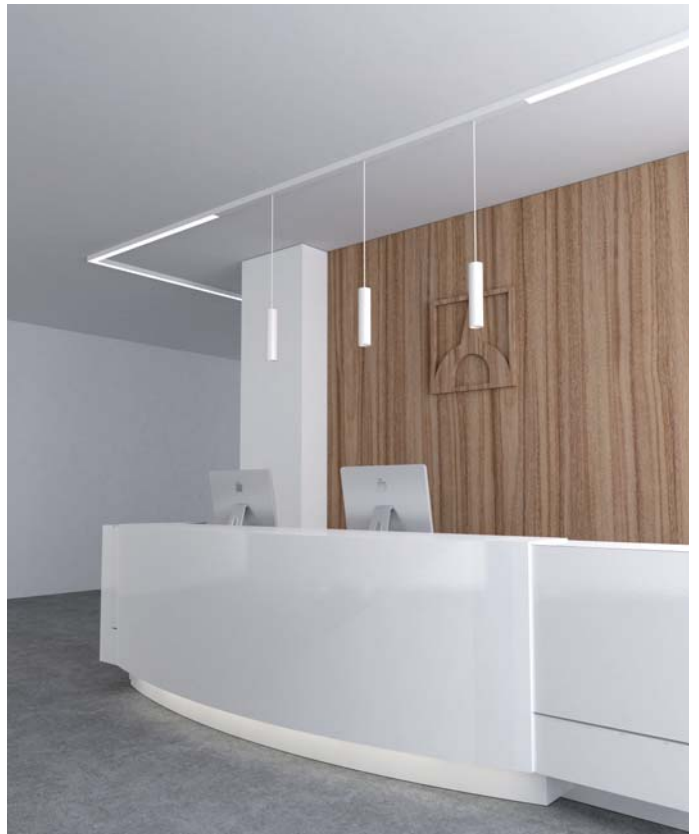
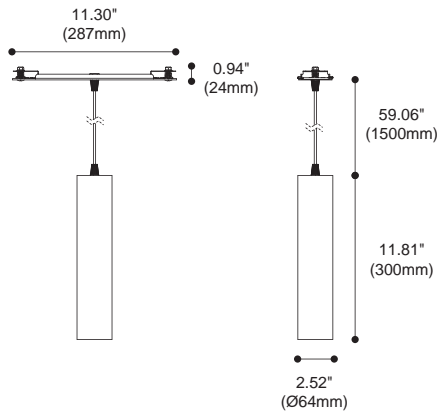

- Colours Black White
- Baffle : Black White Copper

Product performance

Article number	LED Consumption	Voltage	Lumen	Beam Angle	CCT/CRI
1717.111-AM	6.4W	230V AC	542 (lm)	10°/20°	30/90+
1717.110-AM	12.8W	230V AC	1387 (lm)	10°/20°/30°	30/90+

